

Dynamic L2 + Dynamic XM

Art.-Nr. 536 621

Seite / Page / Page / Bladzijde / Página /
Pagina / Pagina / Страница / 页次.....50

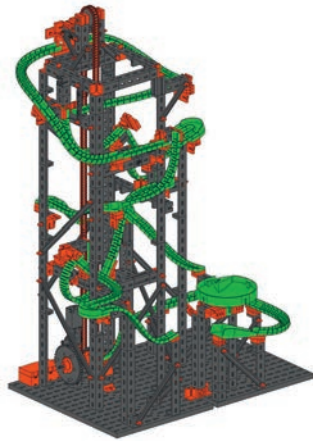





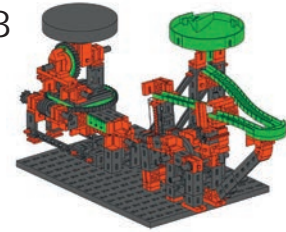

Art.-Nr. 544 618

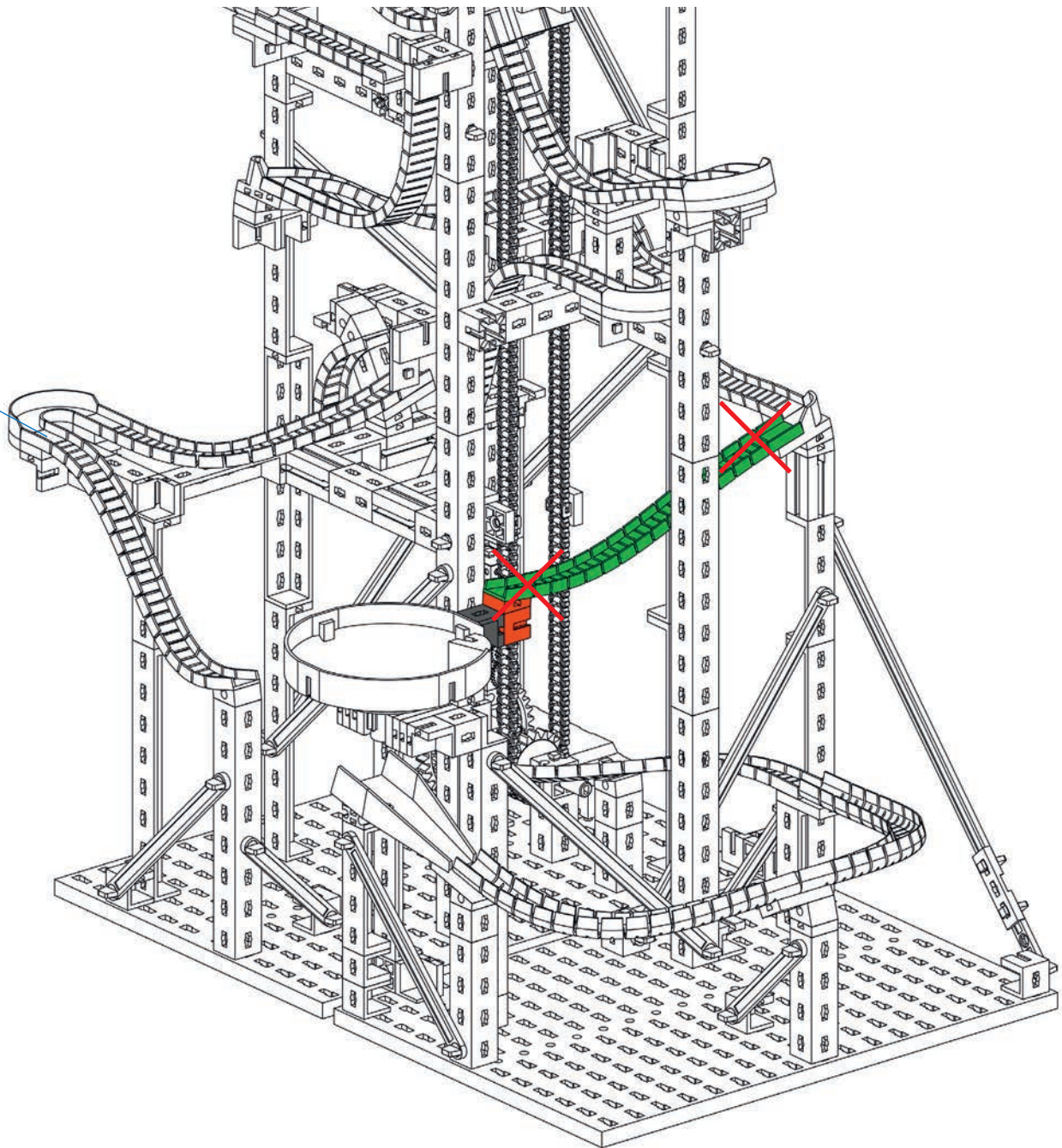
Seite / Page / Page / Bladzijde / Página /
Pagina / Pagina / Страница / 页次.....4





L2

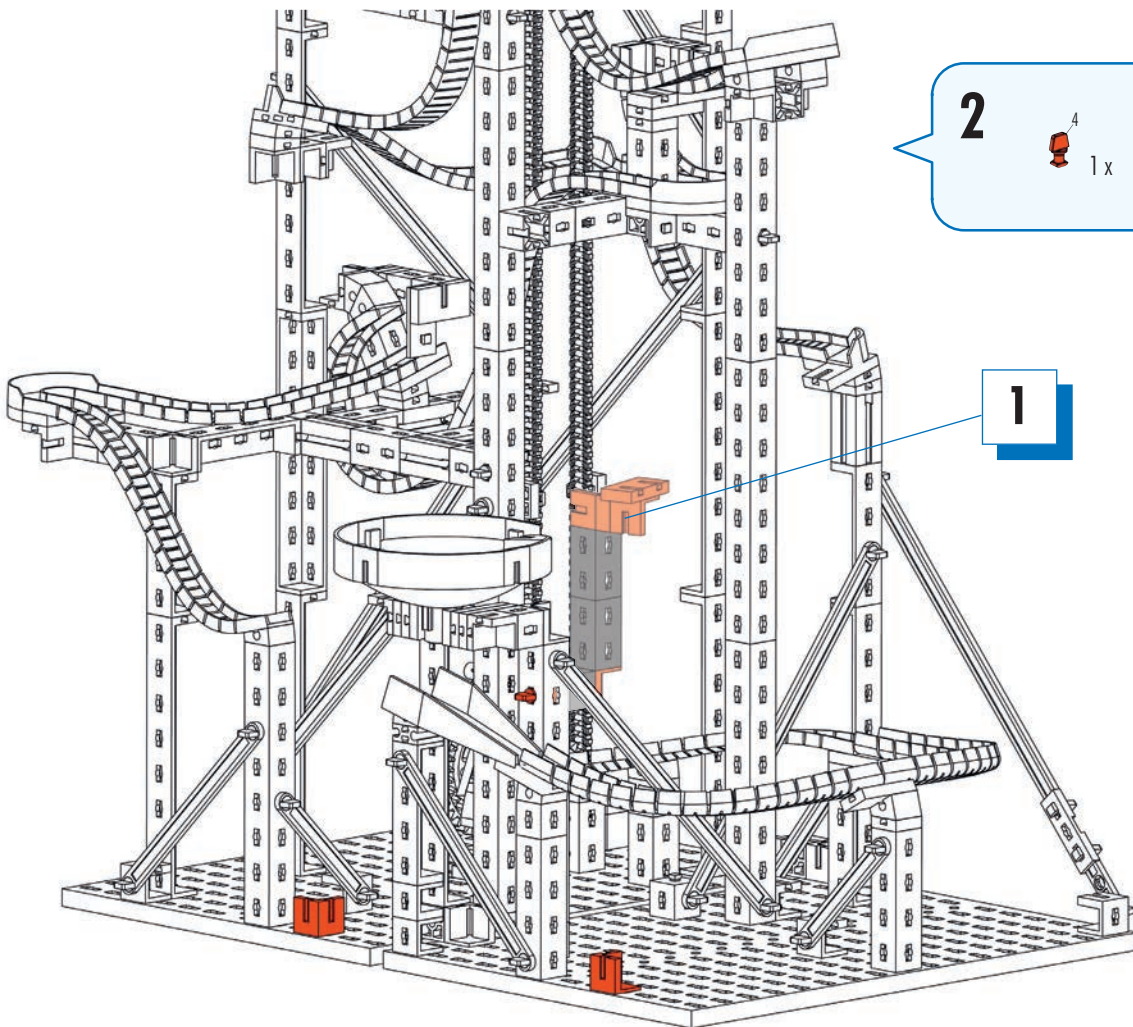
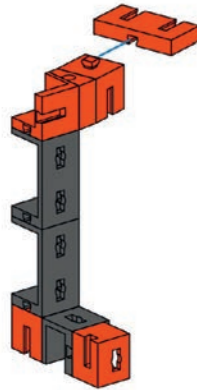

- 1**
-  2 x
 -  1 x
 -  3 x
 -  1 x
 -  1 x
 -  1 x



- 2**
-  1 x
 -  2 x

3

- 3x (Orange L-shaped Technic brick)
- 1x (Orange 1x2 Technic brick)
- 2x (Grey Technic axle connector)
- 2x (Grey Technic axle connector)

XM

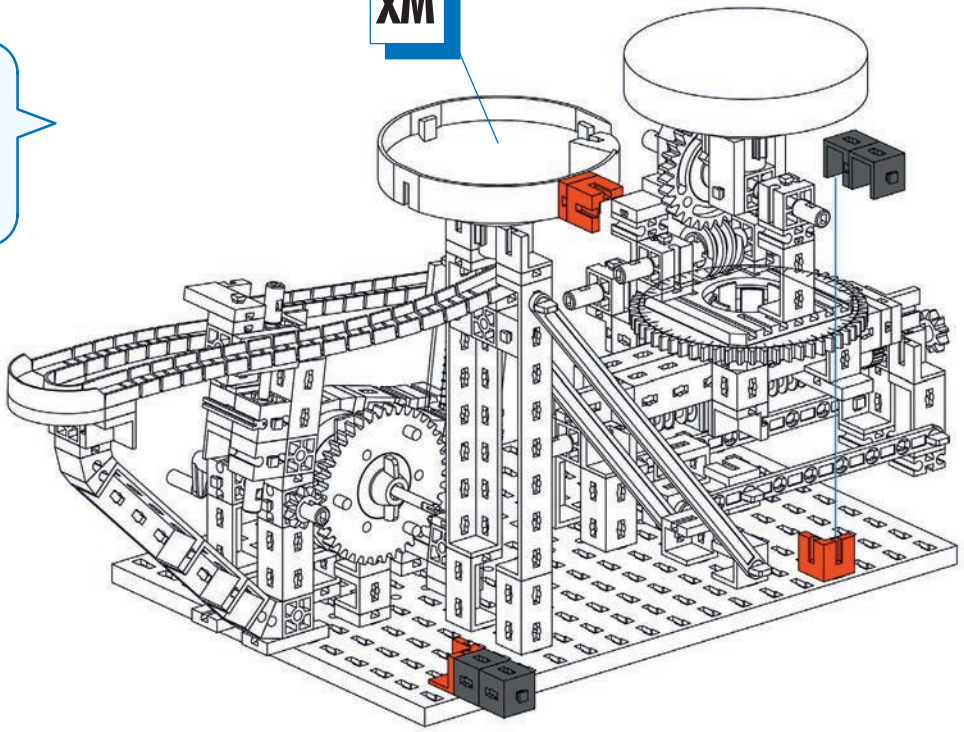

4

- 1x (Green Technic axle)
- 1x (Green Technic axle)
- 1x (Black Technic axle, length 60)
- 1x (Black Technic axle, length 120)
- 4x (Red Technic axle pin)

L2

XM

